



## ***Corner Protectors***

Corner Protectors are designed to protect your cabinets in the manufacturing process and during shipping. **TENN-TEX** Plastics has designed Corner Protectors to fit all of your face frame cabinet applications. When installed on the bottom of your base cabinets, they keep the cabinet off the floor and prevent handling damage. Protect your upper cabinets by installing the Corner Protectors on all 8 corners. Corner Protectors are available for 90 Degree Base and Upper Cabinets, 22.5 Degree and 45 Degree Specialty Cabinets and 135 Degree Lazy Susan Cabinets. **TENN-TEX** Plastics offers you ***The Simple Solution*** for Protecting the Corners of your Cabinets.

**T-430**

- T-430-01 Natural
- T-430-02 Black

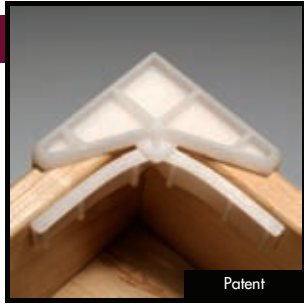

**90° Corner Protector**

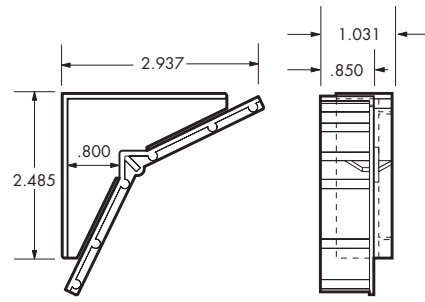

 
19
003
600
9,600

**T-431-01**

- T-431-01 Natural
- T-431-03 Black



**22.5° Corner Protector, Left**

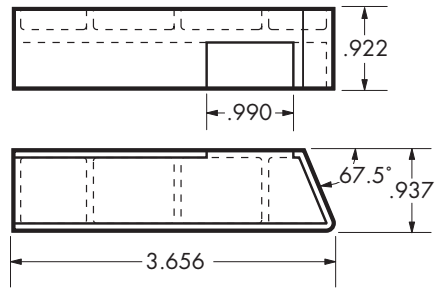

 
10
004
250
5,250

**T-431-02**

- T-431-02 Natural
- T-431-04 Black

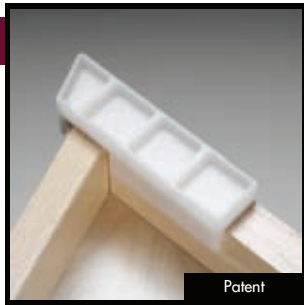

**22.5° Corner Protector, Right**

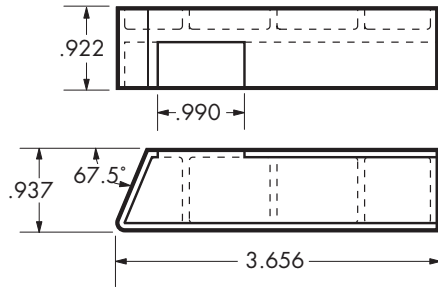

 
10
004
250
5,250

**T-432-01**

- T-432-01 Natural
- T-432-03 Black

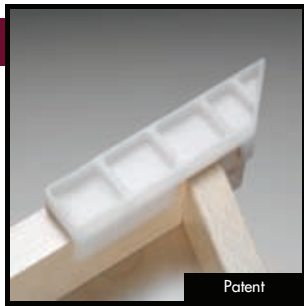

**45° Corner Protector, Left**

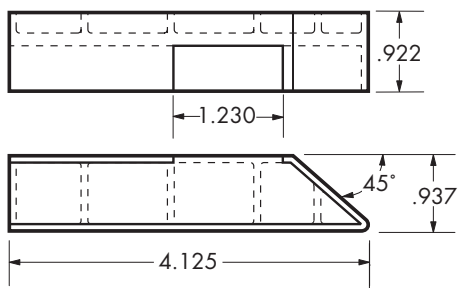

 
11
004
250
5,250

### T-432-02

T-432-02  
T-432-04

Natural  
Black

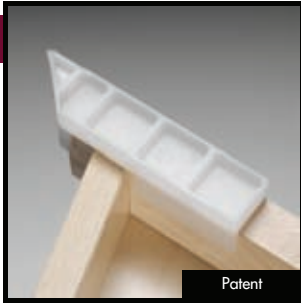

### 45° Corner Protector, Right

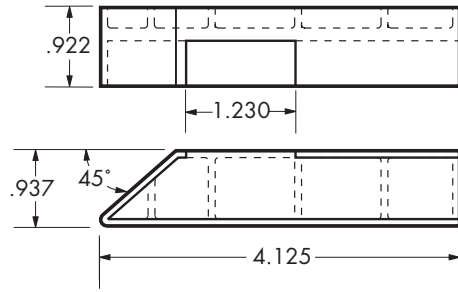

004 250



5,250

### T-433

T-433-01  
T-433-02

Natural  
Black

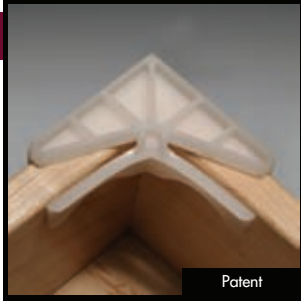

### 90° Mini Corner Protector

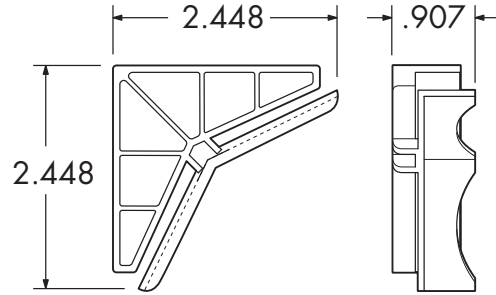

003 800



9,600

### T-435

T-435  
T-435-01

Natural  
Black

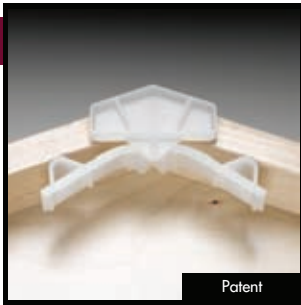

### 135° Corner Protector

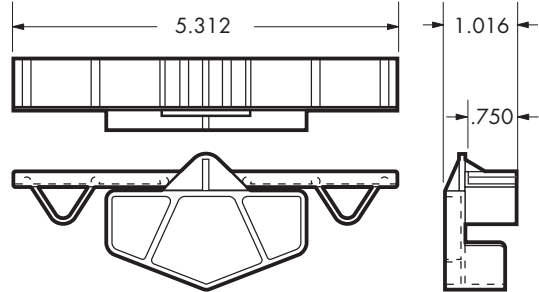

001 500



9,000

