



Corner Braces

Corner Braces are designed to stabilize and strengthen the cabinet during the manufacturing process. They are installed in the top section of the base cabinet and are helpful in securing the countertop. **TENN-TEX** Plastics produces a variety of different styles. A special 135 degree Corner Brace for your Lazy Susan Application is also available. Please contact us for ***The Simple Solution*** for your Corner Brace Applications.

T-400

T-400
T-400-01

- Natural
- Beige



Patent

Center Brace w/ Horizontal Tabs

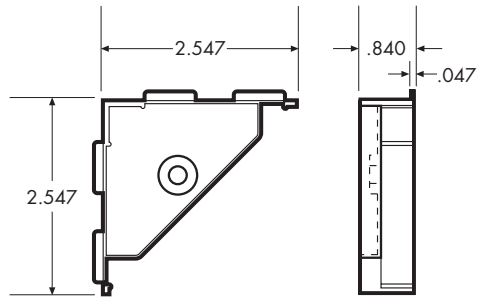

1,000



18,000

T-405-00

T-405-00

Brown

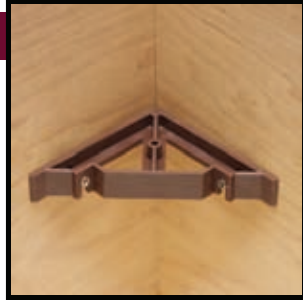

Screw-on Corner Brace

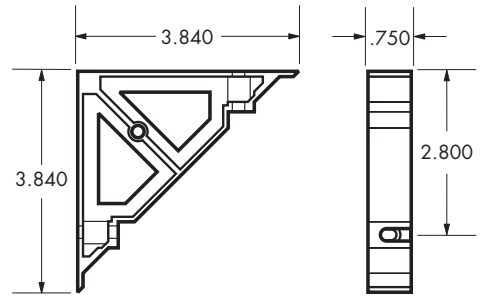

400



7,200

T-410

T-410
T-410-01
T-410-02

- Natural-PE
- Vanilla-PE
- Beige-PE



Corner Brace

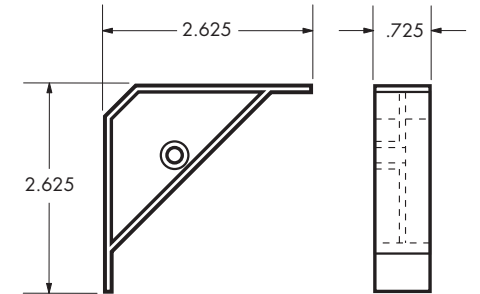

1,000



18,000

T-411

T-411
T-411-01
T-411-02
T-411-03

- Natural
- Vanilla-PE
- Beige-PE
- White



Corner Brace w/ Horizontal Tabs

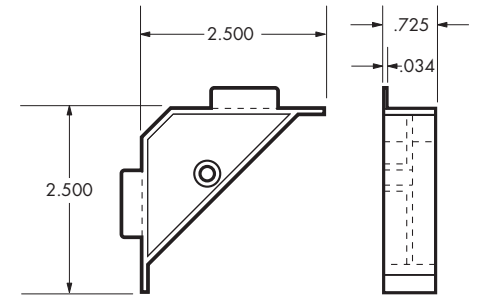

1,000



18,000

T-412

- T-412 Natural-PE
- T-412-01 Vanilla-PE
- T-412-02 Beige-PE



Corner Brace w/ Vertical Tabs

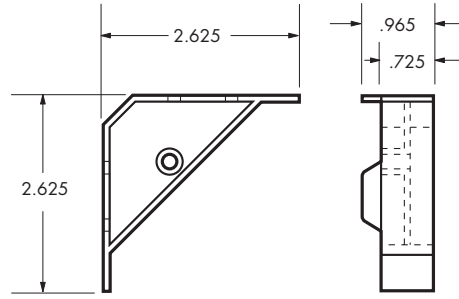

1,000



18,000

T-413

- T-413 Natural-PE
- T-413-01 Vanilla-PE
- T-413-02 Beige-PE



Corner Brace w/ Horizontal Tabs

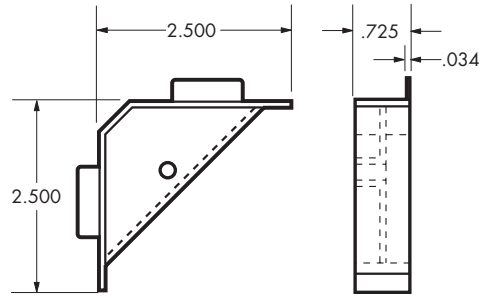

1,000



18,000

T-414-02

- T-414-02 Beige-PE



Corner Brace w/ Horizontal Tabs

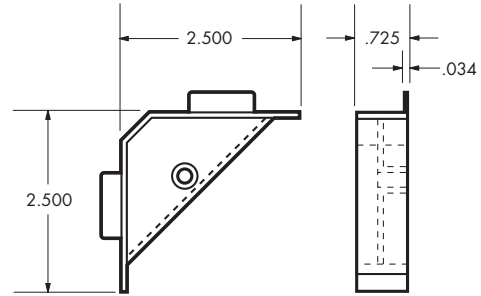

1,000



18,000

T-415

- T-415 Natural

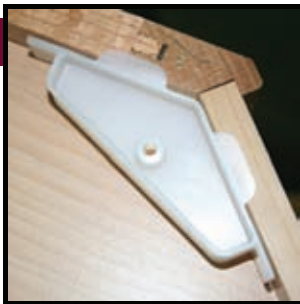

135 Degree Corner Brace w/ Horizontal Tabs

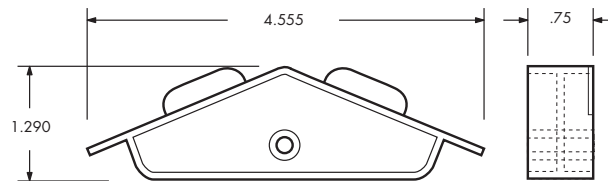

1,000



18,000

